

SUPPLIER: THIS MANUAL MUST BE GIVEN TO THE USER OF THIS PRODUCT.

USER: BEFORE USING THIS PRODUCT, READ THESE INSTRUCTIONS AND SAVE FOR FUTURE REFERENCE.

THIS MANUAL MUST BE USED IN CONJUNCTION WITH YOUR *SELECTAIR*[®] LOW AIR LOSS MATTRESS SYSTEM OPERATIONS MANUAL.

Table of Contents

Section 1	Intended Use	2
Section 2	Warnings and Cautions	2-3
Section 3	Parts Detail	4
Section 4	Product Specifications	5
Section 5	Setup & Removal Instructions	6-8
Section 6	Cleaning and Disinfecting	9
Section 7	Troubleshooting	10
Section 8	Repair, Return, and Contact Information	10
Section 9	Disposal	10
Section 10	Limited Warranty	11

Made in the U.S.A. by ROHO, Inc.
100 North Florida Avenue, Belleville, IL 62221-5429 USA
Phone: 1-800-851-3449 Fax: 1-888-551-3449
www.therohogroup.com • cs@therohogroup.com

© ROHO, Inc., 2008

The following are trademarks and registered trademarks of ROHO, Inc.: ROHO[®], *SelectAir*[®], *SelectAir Max*[®], and *SelectProtect*[™].

ROHO, Inc. has a policy of continual product improvement and reserves the right to amend specifications presented in this manual.

INTENDED USE

The *SelectProtect*[™] is a safety enhancement system intended to aid in the reduction of patient falls and increase bed-bound safety. It is intended to be used without bed side rails. The *SelectProtect* is designed to be integrated only with ROHO[®] *SelectAir*[®] Low Air Loss Mattress Replacement Systems (“*SelectAir*”) using *SelectAir* mattress replacements listed in the Product Specifications section, a mattress pad, and either a *SelectAir* Control Unit or *SelectAir Max*[®] Control Unit. Use of the *SelectProtect* should be determined based upon facility protocols, applicable laws, regulations, guidelines and individual user safety considerations. It does not replace the need for patient fall prevention measures.

The *SelectProtect* is intended for patients that weigh 75 to 400 lbs., the same weight limit established for the applicable Standard *SelectAir* and *SelectAir Max* Mattress Replacement Systems.

CLINICIAN CONSULTATION: ROHO, Inc. recommends that a clinician be consulted to determine if the *SelectProtect* is appropriate for the patient’s particular needs.

CONTRA-INDICATIONS

The *SelectProtect* is not a restraint device. It is not designed to limit the patient’s movements on the mattress or restrict the caregiver’s access to the patient.

 **WARNINGS**

SUFFOCATION RISK: The *SelectProtect* must not be used by infants or other people who are at risk of suffocation. To reduce the risk of suffocation:

- Situate patient with head as close to headboard as possible.
- Reposition patient with head as close to headboard as possible upon reclining after upright mode.
- **DO NOT** allow patient to lie on stomach.
- Check on patient at least once a day while using the *SelectProtect*.

 **WARNINGS CONTINUED**

FALL RISK: Properly trained and knowledgeable care givers should determine whether to use pads, additional bolsters, alarms, high-low beds, or other positioning aids and safety devices that are available on the market to reduce the risk of entrapment or falls. To reduce the risk of falls:

- Ensure patient is properly immersed (Refer to Setup in the *SelectAir* Operations Manual). Fall risk increases if patient is not properly immersed, if the mattress is over-inflated, or if the bed is in an upright position.
- Check on patient at least once a day while using the *SelectProtect*.

ENTRAPMENT RISK:

- **DO NOT** use the *SelectProtect* with bed side rails. This contra-indication supersedes the references to bed side rails currently stated in the *SelectAir* Low Air Low Mattress Systems Operations Manual.

 **CAUTIONS**

- Refer to Safety Precautions and Important Safeguards in the *SelectAir* Operations Manual, and follow all warnings and instructions marked on the control unit and mattress unless otherwise specified in this manual.
- **DO NOT** use the *SelectProtect* with any other manufacturer's products, overlays or other *SelectAir* Systems not indicated in the Product Specifications Section.
- **DO NOT** use the *SelectProtect* for patients who weigh under 75 lbs. or over 400 lbs.
- **DO NOT** use the *SelectProtect* for patients with sporadic, uncontrolled movements. Such patients could accidentally fall from the bed.
- Refer to the *SelectAir* Operations Manual for proper setup, care, maintenance of the *SelectAir* mattress replacement, mattress pad, and control unit.

Prior to setup or removal of the *SelectProtect*, always:

- Remove the patient from the mattress.
- Turn the *SelectAir* control unit power entry switch OFF and unplug the power cord per instructions in the *SelectAir* Operations Manual.
- Remove all linens, if applicable.

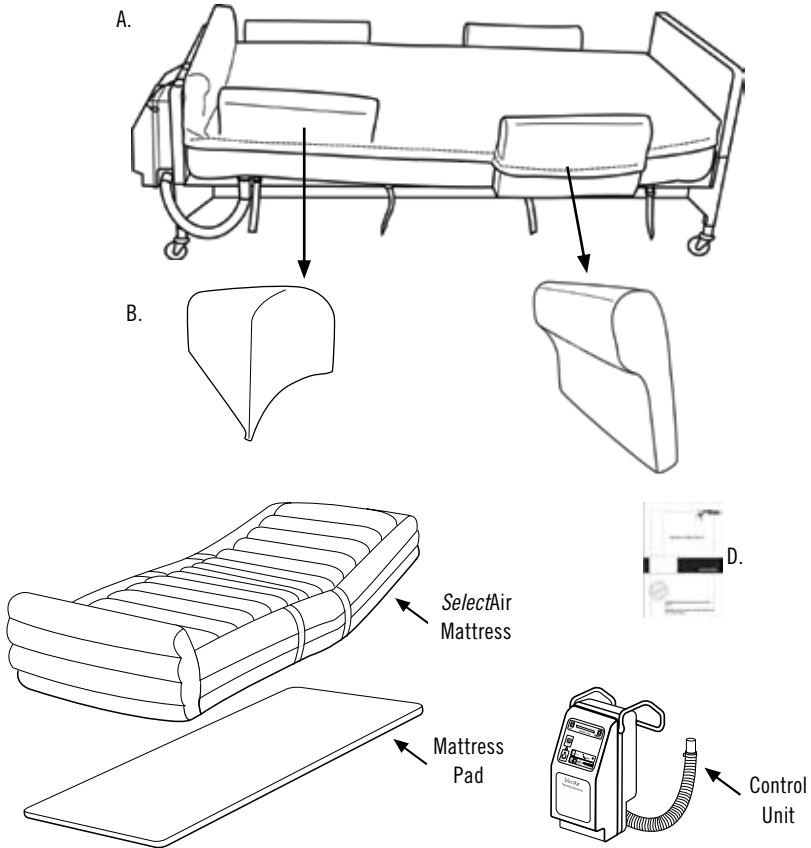
PARTS DETAIL

- A. *SelectProtect* Cover:** The one-piece cover is composed of a top and a bottom section with a zipper on each side. The top section positions both the shoulder and foot bolsters in pockets. The bottom section positions the shoulder bolsters. Four straps are located on each side of the bottom section to secure the cover to the bed frame.
- B. Foot Bolsters:** The two foot bolsters rest within pockets in the top cover section only. The foot bolsters are each marked with an "F" and are interchangeable.
- C. Shoulder Bolsters:** The two shoulder bolsters are inserted into pockets in the bottom cover section near the patient's shoulder area of the mattress assembly and are encapsulated in the top cover section when the zipper is closed. The shoulder bolsters are each marked with an "S" and are interchangeable.
- D. Operations Manual:** Instructions on the *SelectProtect* setup, removal, care and other important information.

PRODUCT SPECIFICATIONS

For <i>Select</i>Air Mattress Item #	Use <i>Select</i>Protect Item #
SASTDMATT	SAPROTECTSTD
SA2SHORTMATT	SAPROTECTSHORT
SANOFTMATT	SAPROTECTNOFT

Materials:

The cover top is 100% polyurethane coated polyester which is fluid resistant, anti-microbial and the cover bottom is 100% PVC (DEHP and BPA free) backed polyester. The bolsters are made of polyurethane foam. The bolster covers are nylon.

SETUP & REMOVAL INSTRUCTIONS**Prior to setup or removal of the *SelectProtect*, always:**

- Remove the patient from the mattress.
- Turn the *SelectAir* control unit power entry switch OFF and unplug the power cord. Refer to the *SelectAir* Operations Manual for instruction.
- Remove all linens, if applicable.

To combine the *SelectProtect* with a *SelectAir* System, some disassembly and re-assembly will be required. The original *SelectAir* cover will not be used during the integration of the systems. The *SelectAir* mattress sheet will not fit the *SelectProtect*.

To Integrate the *SelectProtect* with an existing *SelectAir* Mattress Replacement System:

1. Unzip the existing *SelectAir* cover.
2. Locate the mattress hose fitting where the air supply hose connects to the mattress. Disconnect the air supply hose from the mattress hose fitting and pass it through the access hole in the cover.
3. Remove the *SelectAir* mattress replacement and mattress pad. Set aside for use with the *SelectProtect*.
4. Unstrap and remove the *SelectAir* cover.

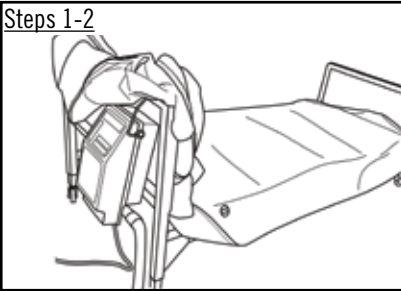
To set up the *SelectProtect*:**Steps 1-2**

1. Place the *SelectProtect* cover on the bed so the air hose access hole is at the foot of the bed.
2. Using only one zipper pull, unzip the cover and drape the top section over the foot of the bed frame.

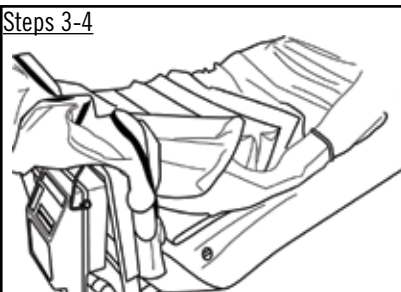
Steps 3-4

3. Place the mattress pad inside the bottom section of the cover.
4. Place the *SelectAir* mattress replacement on top of the mattress pad with the air inlet fitting positioned at the foot of the bed.

Steps 5-6

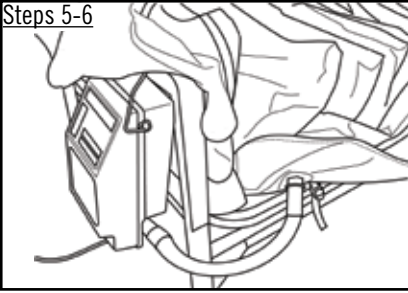

Steps 8-9

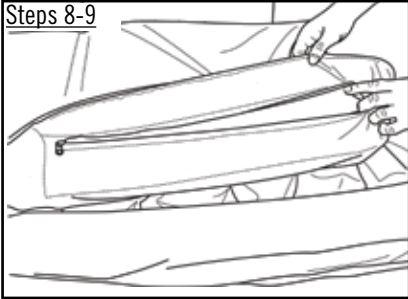

Step 10

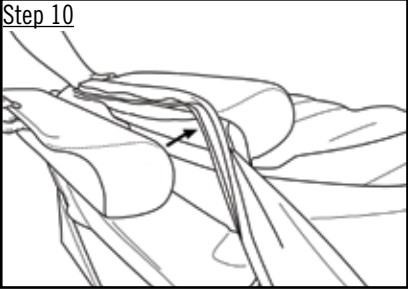

Step 13



5. Locate the *SelectAir* mattress hose fitting and feed it through the access hole in the bottom of the cover.
6. Press the mattress hose fitting into the fitting on the air supply hose.
7. Place the top section of the *SelectProtect* cover over the mattress.
8. At the foot of the mattress, lift one side of the cover's top section until the foot bolster pocket's zipper is visible. The pocket zipper is on the underside of the cover top.
9. Unzip the pocket.
10. Insert a foot bolster so the tapered end will be facing down and away from the bed.
11. Zip the pocket shut.
12. Repeat steps 8-11 for the second foot bolster.
13. Zip the cover shut until you reach a shoulder bolster pocket.

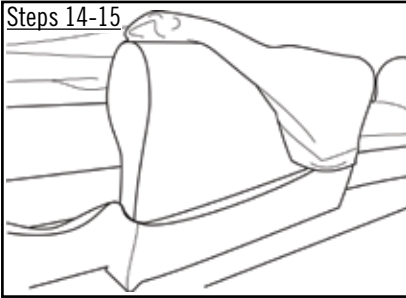

14. Insert the tapered end of a shoulder bolster into the pocket in the bottom cover section so it will be facing away from the bed.
15. Guide the shoulder bolster into the top cover pocket while zipping the pocket shut.
16. Repeat steps 13-15 for the second shoulder bolster and then zip the cover closed.

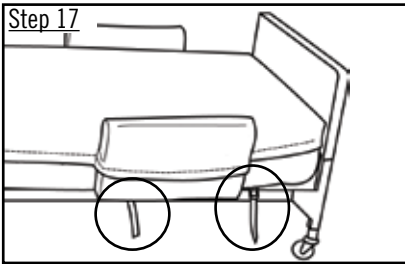

- Note:** If the *SelectAir* mattress replacement has a foot pillow, tuck it into its pocket in the top section of the cover before zipping it shut.
17. Secure the safety straps on the bottom cover section to the bed frame.
 18. Plug in the control unit and turn it on (refer to the *SelectAir* Operations Manual).

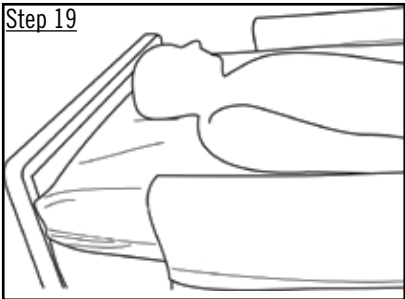

19. Transfer the patient onto the bed, positioning head close to the headboard and in line with the opening between the shoulder bolsters and the headboard.
20. Refer to the *SelectAir* Operations Manual and the control unit for proper inflation for patient.

To Remove the *SelectProtect*:

1. Unzip the cover.
2. Partially fold the top section of the cover away to expose the shoulder bolsters.
3. Remove the shoulder bolsters from their pockets.
4. Unzip the foot bolster pockets and remove the foot bolsters.
5. Fold the top section of the *SelectProtect* cover toward the foot of the bed.
6. Disconnect the *SelectAir* mattress replacement hose fitting from the air supply hose.
7. Remove the mattress and mattress pad.
8. Unstrap the *SelectProtect* cover and remove it from the bed.

CLEANING AND DISINFECTING

Note:

- Cleaning and disinfecting are two different processes. To be effective, cleaning must precede disinfecting.
- The *SelectProtect* must be cleaned, disinfected, and checked for proper functioning between multiple patient use.
- Disassemble the *SelectProtect* before cleaning or disinfecting any of its components between patients.

To clean the *SelectProtect* cover while in use:

Wipe surface with pH neutral soap and warm water. Rinse with water and dry.

To clean *SelectProtect* cover between patients:

Remove cover from mattress and remove foam bolsters from pockets. Machine wash in warm water. No bleach, Tumble dry low.

DO NOT use high heat.



To disinfect *SelectProtect* cover between patients:

Machine wash in hot water (sanitizing cycle). No bleach. Tumble dry low.



Note: Disinfectants are not effective on porous surfaces such as foam. If the foam bolsters become soiled or contaminated, **DO NOT** use. Replacement foam bolsters may be purchased. Replace the foam bolsters with components supplied by ROHO, Inc. only.

For cleaning and disinfecting the *SelectAir* mattress replacement, mattress pad, or control unit during use or between patients, refer to the instructions in the *SelectAir* Operations Manual.

TROUBLESHOOTING

Problem:	Action:
A Component of the <i>SelectProtect</i> appears flat or misshapen after setup or during use:	<ul style="list-style-type: none"> • Check to ensure zippers are completely closed. • Check for tears or broken seams in pockets. • Check to ensure foam bolsters are properly inserted within appropriate pockets. • Check for loose components or visible damage to component or assembly.
<i>SelectProtect</i> Assembly looks “uneven” or zippers don’t close:	<ul style="list-style-type: none"> • Check to ensure bolsters are properly positioned inside their appropriate pockets.

If any problem persists, contact our Customer Service Department.

REPAIR

If you require a repair, you may return the product for assessment. Before returning your product to ROHO, Inc. for repairs, contact our Customer Service Department at 1-800-851-3449 toll free for a Return Authorization Number. A Return Authorization Number must be obtained from ROHO, Inc. and a Return Authorization Form must be included with your product when returned. A Return Authorization Form can be obtained from our website at www.therohogroup.com or by contacting Customer Service.

Be advised that a charge will be assessed for any service provided for a product that does not qualify under the product's warranty. Failure to submit a Return Authorization Form may result in the product being returned without evaluation or repair.

RETURNS

All returns require prior authorization from ROHO, Inc. and are subject to a restocking charge. Before returning your product, contact our Customer Service Department at 1-800-851-3449 toll-free.

**DISPOSAL**

When properly used and disposed, there are no known environmental hazards associated with the components of *SelectProtect* systems. Dispose of the product and/or components in accordance with the applicable regulations in your jurisdiction. **DO NOT INCINERATE.**

Limited Warranty

What Is Covered?

ROHO, Inc. covers any defects in materials or workmanship of the product. Any substitutions of supplied components will void the warranty.

For how long?

12 months from the date the product was originally purchased.

What We Will Do.

Within a reasonable amount of time after you return the product to us, we will repair or replace any defect in material and workmanship and ship it back to you, all free of charge.

What We Will Not Do.

We will not repair a product free of charge if it has been misused, damaged by an accident, or damaged from "an act of Nature", e.g., flood, tornado, earthquake, fire.

What The Customer Must Do.

The customer must contact ROHO, Inc. to obtain a Return Authorization Number and a completed Return Authorization Form must be included with the product when returned. The Return Authorization Form can be obtained from our website at www.therohogroup.com or by contacting our Customer Service Department toll-free at 1-800-851-3449.

Failure to submit a Return Authorization Form may result in the product being returned without evaluation or repair.

Questions?

Call our Customer Service Department toll free at 1-800-851-3449 or e-mail us at cs@therohogroup.com.

Disclaimer.

Any implied warranties, including the MERCHANTABILITY and FITNESS FOR A PARTICULAR PURPOSE are also limited to the period of time specified above from the date of original purchase and any action for a breach of such warranties or any express warranties herein must be commenced within this time. ROHO, Inc. shall not be responsible for any incidental or consequential damages with respect to economic loss or injuries to property, whether as a result of a breach of express or implied warranties, or otherwise. ROHO, Inc. will not be responsible for the results of careless handling, unreasonable or improper use of this product.

Your Rights and the Effect of this Warranty upon Them.

This warranty restricts the duration of all implied warranties as noted above and limits or excludes recovery for incidental or consequential damages. Some jurisdictions do not allow limitations on how long implied warranties will last and some jurisdictions do not allow the exclusion or limitation of consequential or incidental damages, so those provisions may not apply to you. While this warranty gives you specific legal rights, you may also have other rights which vary from jurisdiction to jurisdiction.

Note: Refer to *SelectAir* Operations Manual for warranty information on the *SelectAir* mattress replacement, mattress pad, and control unit.



The Quality Management Systems of ROHO, Inc. are certified to ISO 9001:2000 and ISO 13485:2003.

